

Hand Drawn—Wide Channel

4100 Track System

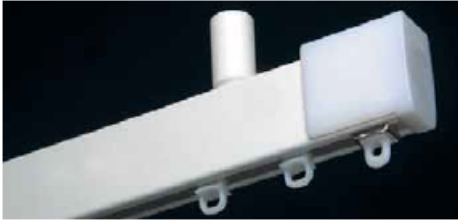



4100– The Classic Heavy Duty Curtain Rail System

This premier profile of classic design is one of the strongest tracks in the T 000 Range, with the ability to span up to 260cm between bracket centres, profile 4100 is especially appropriate for wide window situations where fixing points are limited. System 4100 is suitable for many curtain applications and is particularly suitable for very heavy curtain when assembled with rollers or our technically advanced heavy duty gliders. Already established within the commercial sector this profile is now in demand for the design lead domestic market.

Standard colours: White RAL 9010, natural. Special colours on request.

Installation

curtain rails

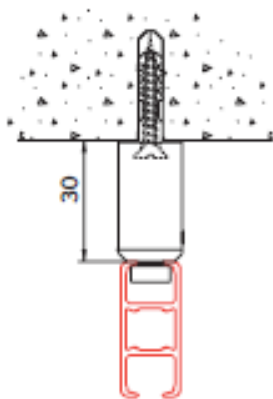

ceiling fixing with mini-suspension hanger 4254

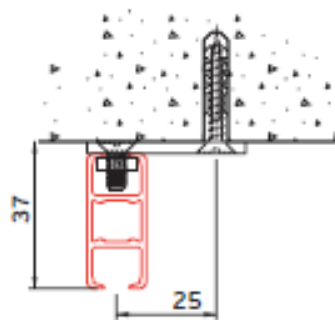

top fixing with ceiling fixing plate 4135

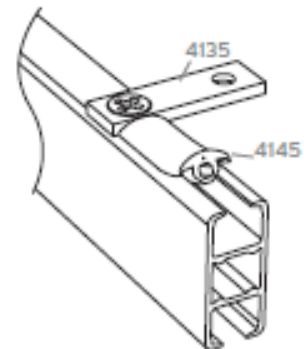

top fixing with ceiling fixing plate 4135 and dust cover 4145 (for gap closure)

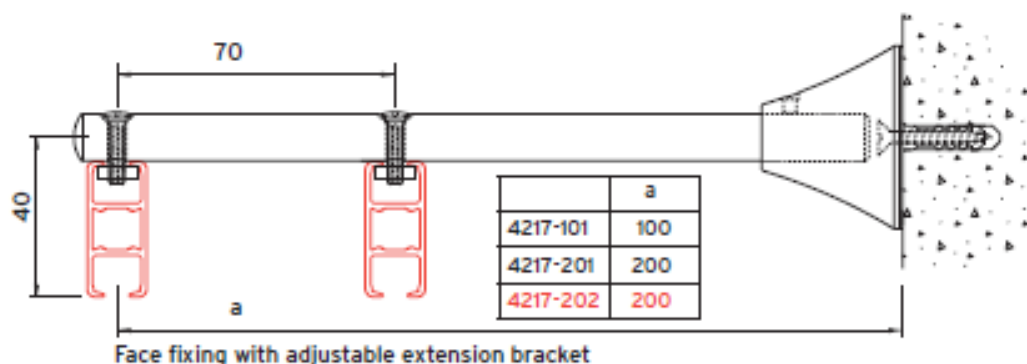

Face fixing with adjustable extension bracket

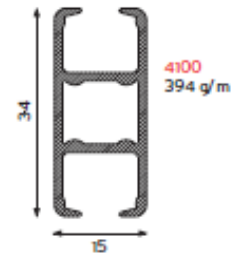
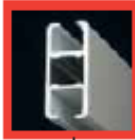

Specification Guide

Material:

Aluminium 606035-T6-F22. (Higher specification than DIN 1725).
 Shape and size tolerances are in accordance with DIN 17615.
 White RAL 9010 powder coated in accordance with the Qualicoat standard.
 Special colours on request. Profile weight: 394 g/m.

Accessories:

Gliders 4010 at 10-16 per metre with 2 end stops 4001 and 2 end covers 4153 per length.

Installation:

Ceiling fixing with ceiling fixing plate 4135 or mini-suspension hanger 4254.
 Face fixing with wall support 4150, adjustable extension bracket 4217 or extension bracket 4115.

Bracket fixing centres in accordance with the G-Standard or the following table.

light	medium	heavy (curtain)
200 cm	150 cm	110 cm

Bending:

Minimum radius 20 cm. Bending machine 1015.

HAND DRAWN
WIDE CHANNEL

4100



Standard (bracket fixing guide)

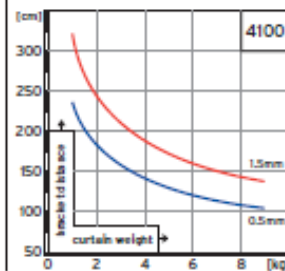

end fixing with wall support 4150

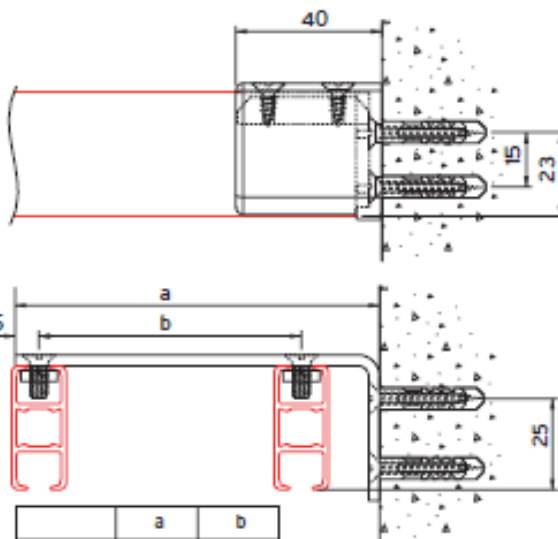

	a	b
4115-07.5	75	47
4115-10	100	72
4115-15	150	72

face fixing with extension bracket 4115-10



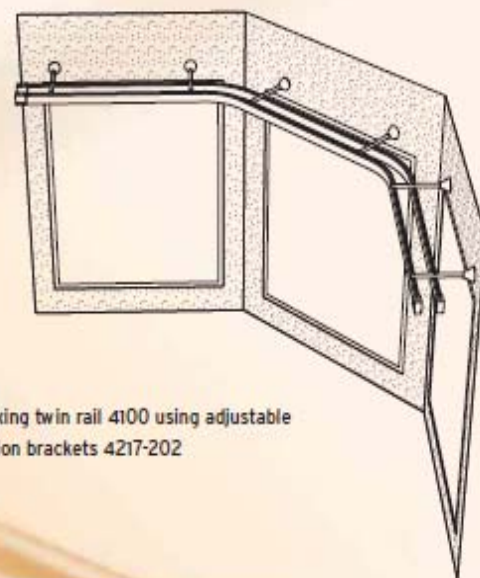

























Product example



Face fixing twin rail 4100 using adjustable extension brackets 4217-202

Components

Product design and specification changes reserved.

CURTAIN TRANSPORT					
	4001 endstop colours: B - G - W		2020 double hook		4150 wall support colours: B - GR - W
	4001-A endstop with eye (metal)		2021 G-hook	ACCESSORIES	
	4002 endstop		2022 curtain hook		4153 endcover colours: B - GR - W
	4003 spring stop		4048-10 corner connection with eye		2024-55 adjustable sew-in hook
	4007 rotating glider	CEILING FIXING			4145 dust-cover to close and seal gap when using 4135 fixing plates colours: B - GR - W
	4010^P Glider (on strip) colours: B - G - W - ZW		4135 ceiling fixing plate colours: N - W		4048-10-Z0 corner connection without eye (for top of rail)
	4012-10 click glider	WALL FIXING			5080 overlap carrier to be used in combination with a drawrod:
	4012-40 click glider transversed		4217-202[®] 20 cm		7399 Plexi drawrod
	4012-50 click glider transversed with hook		4217-201[®] 20 cm		7399-WK Steel drawrod white synthetic cover
	4010^P 2023[®] 4025 glider 4010 with hook 2023		4217-101[®] 10 cm adjustable extension bracket B - GM - NM - W		7399-K Plexi drawrod with core
	4030 roller colours: B - G - W - ZW		4115-15 4115-10 4115-07,5 extension bracket (16x3 mm) colours: N - W		

**HAND DRAWN
WIDE CHANNEL**

4100

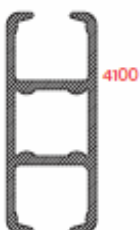

B = Brown
G = Gold
GM = Gold metallic
GR = Grey
N = Natural
NM = Natural metallic
W = White
ZW = Black

▣ = Standard item
® = Registered design
® = Patented design

Bodies & Accreditations

